

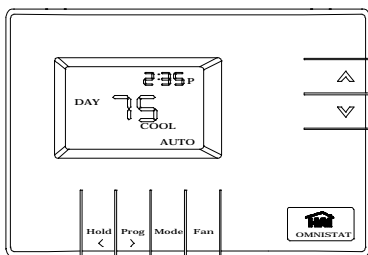

OMNISTAT

ELECTRONIC COMMUNICATING THERMOSTAT



Owner's Manual

RC-120 Two Stage Heat/Cool 2 Stage Heat / 2 Stage Cool

Document Number 13R00-7
January, 1997

**Copyright © 1997 Home Automation, Inc.
All Rights Reserved**

CONTENTS

INTRODUCTION	1
DESCRIPTION	1
MAINTENANCE	1
OPERATION	2
DISPLAY	4
FILTER REMINDER	6
ANTICIPATION	6
SETTING THE CURRENT TIME AND DAY	7
PROGRAMMING	8
SETTING TIME SCHEDULES	9
DAY/NIGHT MODE	10
PROGRAMMABLE ENERGY SAVER MODE (PESM)	10
SYSTEM MODE	11
AUTOMATIC TIME UPDATE	11



This thermostat is Listed by Underwriter's Laboratories and UL Canada.



This thermostat has been tested and found to comply with the requirements of the European Union for Electromagnetic Interference, Electromagnetic Immunity and Safety under the applicable EMI and Low Voltage Directives and Standards.



This thermostat has been tested and found to comply with the limits for a Class B digital device, pursuant to part 15 of the FCC Rules.

This product generates and can radiate radio frequency energy. Due to its low power design, it is unlikely to interfere with radio and TV communications. If it is suspected of doing so, the user is encouraged to try to correct the problem by reorienting the receiver's antenna, moving the receiver away from the product, or consulting an experienced radio/TV technician for help.

INTRODUCTION

Thank you for purchasing your new RC-120 electronic communicating thermostat. Your thermostat will provide you with comfort, convenience, and energy savings for years to come.

We hope that you take a few moments to become familiar with all of the features of this fine product by reviewing this manual. Please keep this manual on file for future reference.

DESCRIPTION

The RC-120 is a precision digital thermostat for two stage heating and cooling systems. It has the capability of being controlled both locally and by remote control. It offers programmability, stand alone operation, and robust, optically isolated communications with automation systems, utility control systems, and personal computers.

There are several items which can be configured at the time of installation. These items have a check box () for your installer to indicate which features are used in your system.

As an EPA ENERGY STAR Partner, Home Automation, Inc. has determined that this thermostat meets the ENERGY STAR guidelines for energy efficiency.



MAINTENANCE

Your new thermostat is maintenance free. There is no battery to install or replace. If necessary, clean unit carefully with a mild soap solution on a soft cloth.

OPERATION

To take advantage of all the benefits and features offered by your thermostat, we recommend that you start by becoming familiar with its operation.

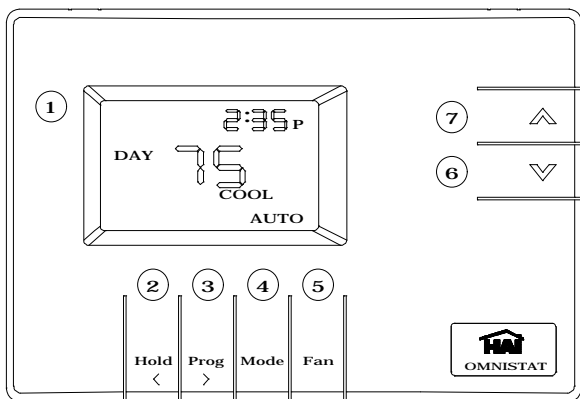

1- Display

The Display is used to show current time, temperature, outdoor temperature (optional), mode, and to give useful information that will guide you through normal operation of your thermostat.

2- Hold

Press the Hold key to set the system into Hold mode. In Hold mode, the thermostat will not change its settings by program.

3- Prog

Press the Prog (programming) key to set the current time and day (hours, minutes, day of week), and to program the temperature time schedules for the MORN, DAY, EVE, and NITE periods.

4- Mode

Press the Mode key to set the thermostat mode to *Off*, *Heat*, *Cool*, or *Auto*.

In *Off* mode, the heating and cooling systems are both off and do not respond to changes in temperature settings.

- In *Heat* mode, the heating system responds to maintain your desired heating setting.
- In *Cool* mode, the cooling system responds to maintain your desired cooling setting.
- In *Auto* mode, your thermostat will automatically switch between heat and cool to maintain your desired heating and cooling settings.

5- Fan

Press the Fan key to set the system fan to *Fan Auto* or *Fan On*.

In *Fan Auto* mode, the fan runs only when the system calls for heating or cooling.

In *Fan On* mode, the fan runs continuously.

6- Down Arrow (▼)

Press the Down Arrow key to lower the desired temperature.

7- Up Arrow (▲)

Press the Up Arrow key to raise the desired temperature.

Note: To check your desired setting without changing it, press the up or down arrow key (▲ or ▼) once.

DISPLAY

The following icons will be displayed during normal operation:

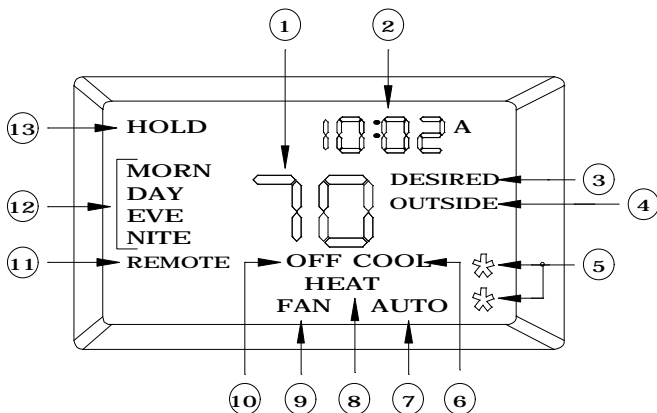

1- Temperature Display

Shows the current temperature, desired temperature, or heating and cooling settings.

2- Time Display

Shows the current time of day.

3- DESIRED

DESIRED is displayed when the temperature display shows the desired temperature setting.

4- OUTSIDE

- OUTSIDE will be displayed when the temperature display shows the outdoor temperature. The outdoor temperature will be displayed every 4 seconds.

5- ★

The *Top* ★ is displayed when Stage 1 of the heating or cooling system is running.

The *Bottom* ★ is displayed when Stage 2 of the heating or cooling system is running.

6- COOL

COOL is displayed when the system is in Cool mode.

7- AUTO

AUTO is displayed when in automatic changeover mode.

8- HEAT

HEAT is displayed when the system is in Heat mode.

9- FAN

FAN is displayed when the fan is set to run continuously.

10- OFF

OFF is displayed when the system is in the Off mode.

11- REMOTE

- REMOTE is displayed when the last command received by the thermostat was sent by a remote system.

12- Period Indicators

MORN, DAY, EVE, or NITE is displayed when scheduled temperature changes are made by the thermostat programs.

13- HOLD

HOLD is displayed when the system is in Hold mode.

FILTER REMINDER

Your thermostat logs the amount of time your heating and cooling system has been running and gives you a reminder when it's time to replace your filter.

" F I L T " will be displayed every four seconds in the place of the time display when it is time to change you filter. To clear the reminder, press the Prog key. The display will return to normal in 10 seconds. Don't forget to change your filter!

ANTICIPATION

Your thermostat has a sophisticated control system designed to keep you comfortable while saving energy. Part of the control system is a feature called "anticipation", which anticipates the need to turn the system on or off before the temperature is actually at the setting.

As humans, we perceive temperature as a combination of heat in the air and heat radiated from the walls and surroundings. The thermostat also measures a combination of air and wall temperature. When heating, the air temperature rises faster than the wall temperature. The thermostat will turn the heat off briefly to prevent overheating the air while the wall temperature catches up. Your comfort is assured without overshooting the heat setting, which wastes energy.

In summer, the thermostat will periodically run the cooling system to circulate the air and remove humidity when the temperature is close, but not above the cool setting. You will be more comfortable at a higher cool setting, which saves energy.

Remember to allow some time for the thermostat to adapt to a new setting.

SETTING THE CURRENT TIME AND DAY

To set or change the current time and day, press and release the Prog key. The hour will blink.

1. Use the arrow keys (\wedge - \vee) to change the hour.

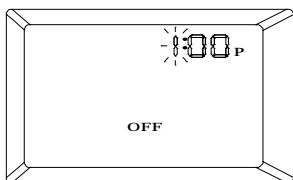

2. Press the Prog key to advance to minutes.
3. Use the arrow keys (\wedge - \vee) to change minutes.

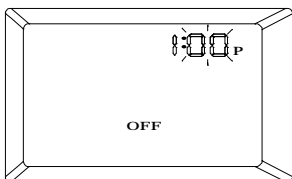

4. Press the Prog key to advance to day of week.
5. Use the arrow keys (\wedge - \vee) to set the day of week (1=Monday - 7=Sunday).

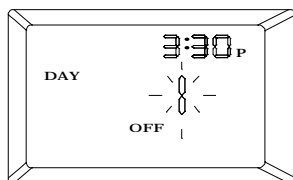

Press the Mode key when complete, or simply wait 8 seconds for the display to return to normal.

□ PROGRAMMING

Your thermostat may be programmed to adjust the heating and cooling settings up to 4 times per day (MORN, DAY, EVE, NITE). You can setup a temperature time schedule for weekdays, Saturday, and Sunday.

To enter programming mode, press the Prog key 4 times.

When in programming mode:

1. The item that is being programmed will flash.
2. The up arrow key (^) is used to increase the value.
3. The down arrow key (v) is used to decrease the value.
4. The Prog (>) key is used to advance to the next item.
5. The Hold (<) key is used to return to the previous item.
6. To exit programming mode, press the Mode key.

The thermostat will automatically exit programming mode after 20 seconds of no key activity.

When programming a time for the Morning, Day, Evening, or Night period, the time will be increased or decreased in 15 minute increments. If the up arrow is pressed at 11:45 PM, or the down arrow is pressed at 12:00 AM, the time display will be blank, indicating that no scheduled temperature changes will be made for that period.

Your thermostat will follow a set of time scheduled programs on weekdays (Monday-Friday), on Saturday, and on Sunday. This will allow you to have different heating and cooling settings on Saturday and Sunday, than you normally would have for weekdays (Monday - Friday). When programming the time schedules, the weekday time schedule is programmed first. The Saturday time schedule is programmed second, and the Sunday time schedule is programmed last.

SETTING TIME SCHEDULES

To view or change the programming time schedules of your thermostat, press and the Prog key four times. The weekday MORN time will flash.

1. Use the arrow keys (\wedge - \vee) to change the scheduled time for the displayed period (MORN, DAY, EVE, or NITE).

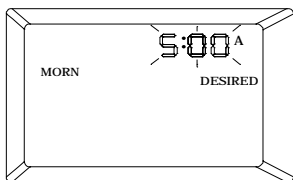

2. Press the Prog key to advance to the next item.
3. Use the arrow keys (\wedge - \vee) to change the desired cool setting.

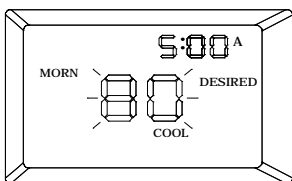

4. Press the Prog key to advance to the next item.
5. Use the arrow keys (\wedge - \vee) to change the desired heat setting.

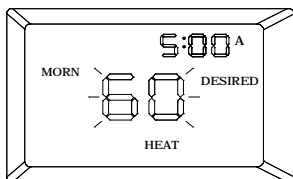

6. Press the Prog key to advance to the next period.

Repeat steps 1-6 for the *DAY*, *EVE*, and *NITE* periods. Afterwards, repeat steps 1-6 for 4 daily periods on Saturdays (Day 6), and 4 daily periods on Sundays (Day 7). The temperature display will show "6" for Saturdays, and "7" for Sunday times.

Note: If *Programming Mode* is not being used and *Day/Night Mode* is being used, only the Weekday - *DAY* and *NITE* settings can be programmed.

DAY/NIGHT MODE

Your thermostat can be configured to change its temperature settings from "DAY" to "NITE" when commanded from a remote location. If so, the thermostat will use the weekday "DAY" and the weekday "NITE" settings.

"REMOTE" and either "DAY" or "NITE" will be displayed when a command is sent from a remote location. You can use the arrow keys (∧-∨) to override the temperature settings, or press the Hold key to prevent any future remote changes.

Follow the procedure shown in *Programming Mode*, to change the programmed *DAY* and *NITE* settings.

PROGRAMMABLE ENERGY SAVER MODE (PESM)

Your thermostat can be configured to allow a remote system to override it. The thermostat sends the temperature to the remote system. The remote system will use the temperature to determine whether or not to override the thermostat based on its own temperature settings.

"REMOTE" will be displayed when the remote system has control of the thermostat. You cannot use the arrow keys (∧-∨) or any other key on the thermostat to override the remote system. To resume normal operation of your thermostat, you must turn the energy saver feature off at the remote system.

SYSTEM MODE

Your thermostat can be connected to an automation system or personal computer. With network software, the remote system can send commands to the thermostat to change mode, cool setting, heat setting, status of fan and hold, and other items.

"REMOTE" will be displayed when a command is sent from the automation system or personal computer. You can use the arrow keys (^-v) on the thermostat to change the temperature settings. When the temperature settings are changed at the thermostat, "REMOTE" will no longer be displayed. Press the Hold key to prevent thermostat programs or the remote system from changing temperature settings. "HOLD" will be displayed at the thermostat.

AUTOMATIC TIME UPDATE

The thermostat time will automatically be updated by the connected automation system.

POWER OUTAGES

The thermostat will restart the heating/cooling system 3 to 8 minutes after the electricity comes back on. All settings and programs are stored permanently, and will not be affected by a power outage.

CLOCK

The thermostat clock is maintained for approximately 25 minutes during an electrical outage.

TIME SCHEDULES

The table below shows the time schedules that are currently set into your thermostat. There is a blank table at the bottom that can be used to plan changes to the current schedule.

	WEEKDAYS	SATURDAYS	SUNDAYS
MORN	6:00 AM	8:00 AM	8:00 AM
COOL	78	78	78
HEAT	70	70	70
DAY	8:00 AM		
COOL	85	85	85
HEAT	62	62	62
EVE	6:00 PM		
COOL	78	78	78
HEAT	70	70	70
NITE	10:00 PM	11:00 PM	10:00 PM
COOL	82	82	82
HEAT	62	62	62

	WEEKDAYS	SATURDAYS	SUNDAYS
MORN			
COOL			
HEAT			
DAY			
COOL			
HEAT			
EVE			
COOL			
HEAT			
NITE			

COOL			
HEAT			

TWO YEAR LIMITED WARRANTY

Home Automation, Inc. (HAI), warrants this product against defects in material and workmanship, under normal use and service, for a period of two (2) years from the date of purchase by the consumer.

During the warranty period, HAI will repair or replace, at its option, any HAI thermostat that fails due to defect.

This warranty does not cover the cost of removal or reinstallation of any thermostat. **This warranty does not cover failure caused by damage to the thermostat while in your possession (other than damage caused by defect or malfunction), or by its improper installation, including failure to follow the written installation and operation instructions, alterations, misuse, or abuse.** The remedies provided for in this warranty are the sole and exclusive remedies therefor. In no event shall HAI be liable for incidental expenses or consequential loss or damages.

Any implied warranties, including warranties of merchantability and fitness for particular use or purpose is limited to a period of two (2) years from purchase date.

This warranty gives you specific legal rights, and you may have other legal rights, which vary from state to state. Some limitations may not apply to you.

For warranty and repair service,

Within Continental United States, send defective unit carefully packaged, postage prepaid, along with description of trouble and return address to:

Home Automation, Inc.
Service Department
5725 Powell Street, Suite A
New Orleans, LA 70123

Outside of Continental United States:

Contact an Authorized Distributor for repair/replacement instructions.

For Customer Service or Technical Support
Call us at (504) 736-9810
Monday - Friday, 9:00 a.m. to 5:00 p.m. Central time